



INSTALL GUIDE

OEM-IDS(RS)-BM1-[OL-RS-BM1]-EN

DOCUMENT NUMBER
20456

REVISION DATE
20150121

FIRMWARE
OEM-IDS(RS)-BM1-[OL-RS-BM1]

HARDWARE
OL-RS-BM1

ACCESSORIES
OL-LOADER (REQUIRED)



NOTICE The manufacturer will accept no responsibility for any electrical damage resulting from improper installation of this product, be that either damage to the vehicle itself or to the installed device. This device must be installed by a certified technician. Please review the Installation Guide carefully before beginning any work.



BEFORE INSTALLATION

- 1- Connect module to computer
- 2- Login to Weblink account
- 3- Flash firmware to module (module is not preloaded with firmware)
- 4- Use accessories accordingly (accessories are sold separately)

BOX CONTENTS

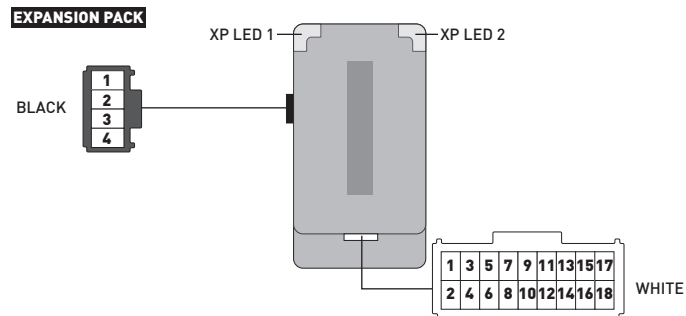
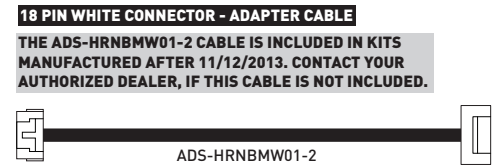
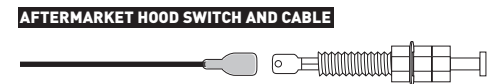
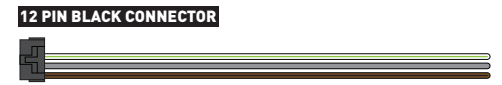
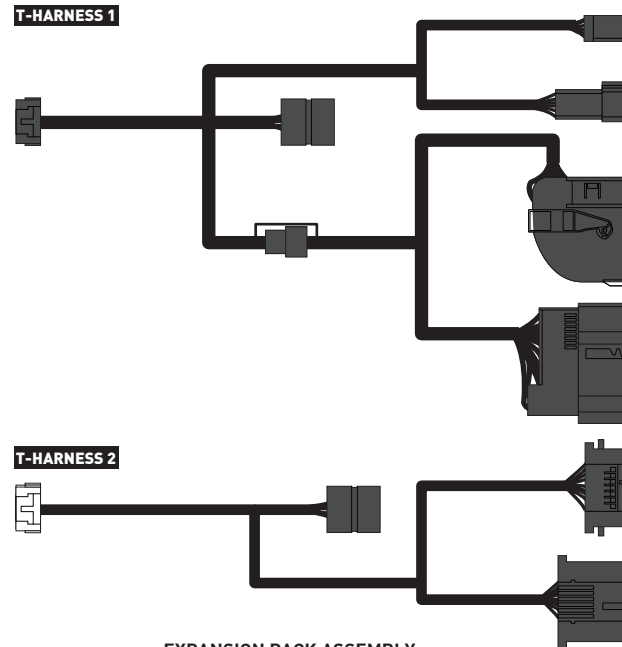
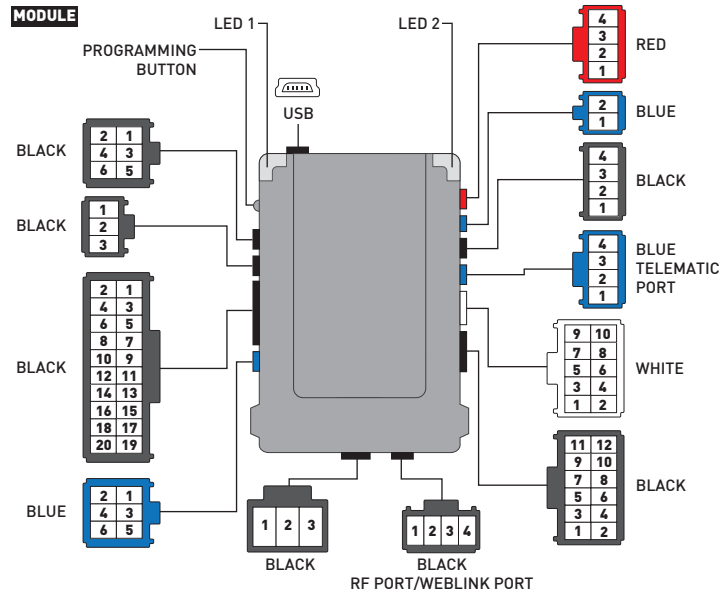

EXPANSION PACK ASSEMBLY

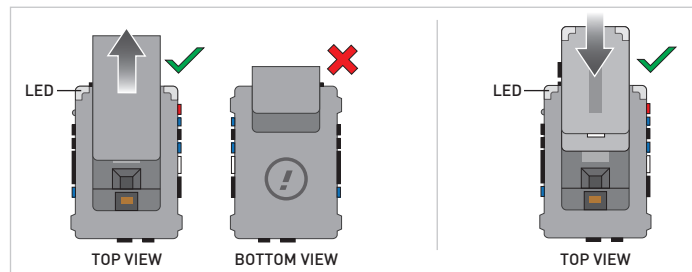

WEBLINK CABLE (required accessory sold separately)

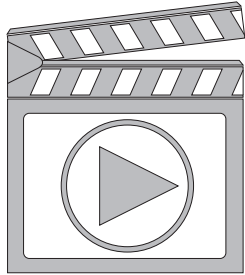

IMPORTANT**INSTALL VIDEO GALLERY AVAILABLE ONLINE**

Before installing this product, consult our Install Video Gallery and watch:

- Vehicle Disassembly Procedure videos
- Module Connection Procedures videos
- Module Programming Procedures videos

Simply visit our forum and register at

<http://www.12voltdata.com/forum/viewtopic.php?f=340&t=9683&sid=a61772b486e4584ad6f058b171ffa425>

01  START vehicle. Verify all vehicle functionalities. If the vehicle displays error messages or any malfunction: stop the installation and service the vehicle.

02  Turn ignition to OFF position. Remove keyfob from keyport.

03  Verify all keyfob functionalities (Door Lock, Door Unlock, Trunk Release and Comfort Access System if equipped).

04  Insert the expansion pack into module.

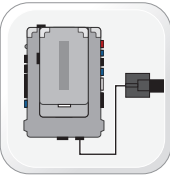
05  Connect the module to the computer with the WEBLINK cable. Flash the module with the latest firmware then flash the expansion pack.

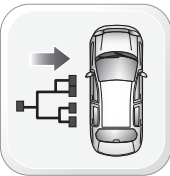
06  Connect and secure every connector to the vehicle, as shown in STEP 1 of the WIRING DIAGRAM.

07  WARNING: Any vehicle harness that is disconnected during installation, must be re-connected before performing any system tests. Failure to comply will result in vehicle displaying error messages. An OEM scantool will be required to clear the error messages.

08  START vehicle. Verify all vehicle functionalities.

09  WARNING: If the vehicle displays error messages or any malfunction, stop the installation, verify every connection and if the problem persists, call technical support.

10  Turn ignition to OFF position. Remove keyfob from keyport.

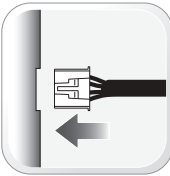
11  Connect and secure every connector to the module, as shown in STEP 2 of the WIRING DIAGRAM.

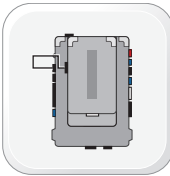
12  Connect and secure every connector of the expansion cable to the module, as shown in STEP 3 of the WIRING DIAGRAM.

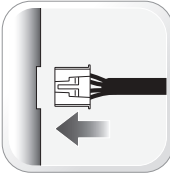
13  If required, connect an accessory as shown in the COMPATIBLE ACCESSORIES section of the guide.

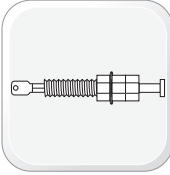
14  If the vehicle is not equipped with a factory hood switch, install an aftermarket hood switch as shown in STEP 4 of the WIRING DIAGRAM.

15  Put sticker 1 on a clean and visible surface in the engine bay and put sticker 2 under the dashboard near the OBDII connector.

16  Module installation procedure completed.

WARNING

- 1-TO CONNECT THE MODULE: FOLLOW STEPS 1 TO 4
- 2-TO DISCONNECT THE MODULE: FOLLOW STEPS 4 TO 1

STEP 2

CONNECT TO MODULE

BLACK 20 PIN

WHITE 18 PIN

WARNING: THE ADAPTER CABLE IS NOT REQUIRED

STEP 3

CONNECT TO MODULE

BLACK 4 PIN

BLACK 6 PIN

STEP 4

CONNECT IF REQUIRED

WHITE 10 PIN

07 GRAY/WHITE - HOOD STATUS (-) INPUT
08 GRAY/BLACK (NOT USED)

STEP 1

CONNECT THE FOLLOWING TO THE VEHICLE
START THE VEHICLE WITH THE OEM KEYFOB
TO TEST THE CONNECTIONS

BRAKE SWITCH

BRAKE HARNESS

COMFORT ACCESS SYSTEM MODULE

MINI: BEHIND INSTRUMENT PANEL, DRIVER SIDE
BMW: UNDER DASH, DRIVER SIDE

B1 CONNECTOR

B2 HARNESS

C1 CONNECTOR

C2 HARNESS

WARNING:
THESE CONNECTORS
HAVE TWO [2X] LOCKING
MECHANISMS.
INSERT THE CONNECTOR
IN ITS HOUSING AND
APPLY GENTLE PRESSURE
ON BOTH EXTREMITIES
TO SECURE THE
CONNECTION. (TWO AUDIBLE
CLICKS WILL BE HEARD.)

IF NOT EQUIPPED
WITH AN OEM HOOD SWITCH,
INSTALL AN AFTERMARKET HOOD SWITCH

HOOD SWITCH

MAKE	MODEL	YEAR	WIRE DESCRIPTION	CONNECTOR NAME	CONNECTOR COLOR	CONNECTOR TYPE	POSITION	WIRE COLOR	POLARITY	MODULE LOCATION	COMPONENT LOCATOR
MINI	Countryman / ALL-4 PTS AT	11-14	12V	X14261	~	51 pin	02	Red/Yellow	(+)	Driver kick panel	~
			Ground	X14261	~	51 pin	47	Brown or Brown/Black	(-)	Driver kick panel	~
			CanH	X14261	~	51 pin	46	Orange/Green	(DATA)	Driver kick panel	~
			CanL	X14261	~	51 pin	45	Green	(DATA)	Driver kick panel	~
	Paceman PTS AT	13-14	12V	X14261	~	51 pin	02	Red/Yellow	(+)	Driver kick panel	~
			Ground	X14261	~	51 pin	47	Brown or Brown/Black	(-)	Driver kick panel	~
			CanH	X14261	~	51 pin	46	Orange/Green	(DATA)	Driver kick panel	~
			CanL	X14261	~	51 pin	45	Green	(DATA)	Driver kick panel	~

WARNING

- 1-TO CONNECT THE MODULE: FOLLOW STEPS 1 TO 4
- 2-TO DISCONNECT THE MODULE: FOLLOW STEPS 4 TO 1

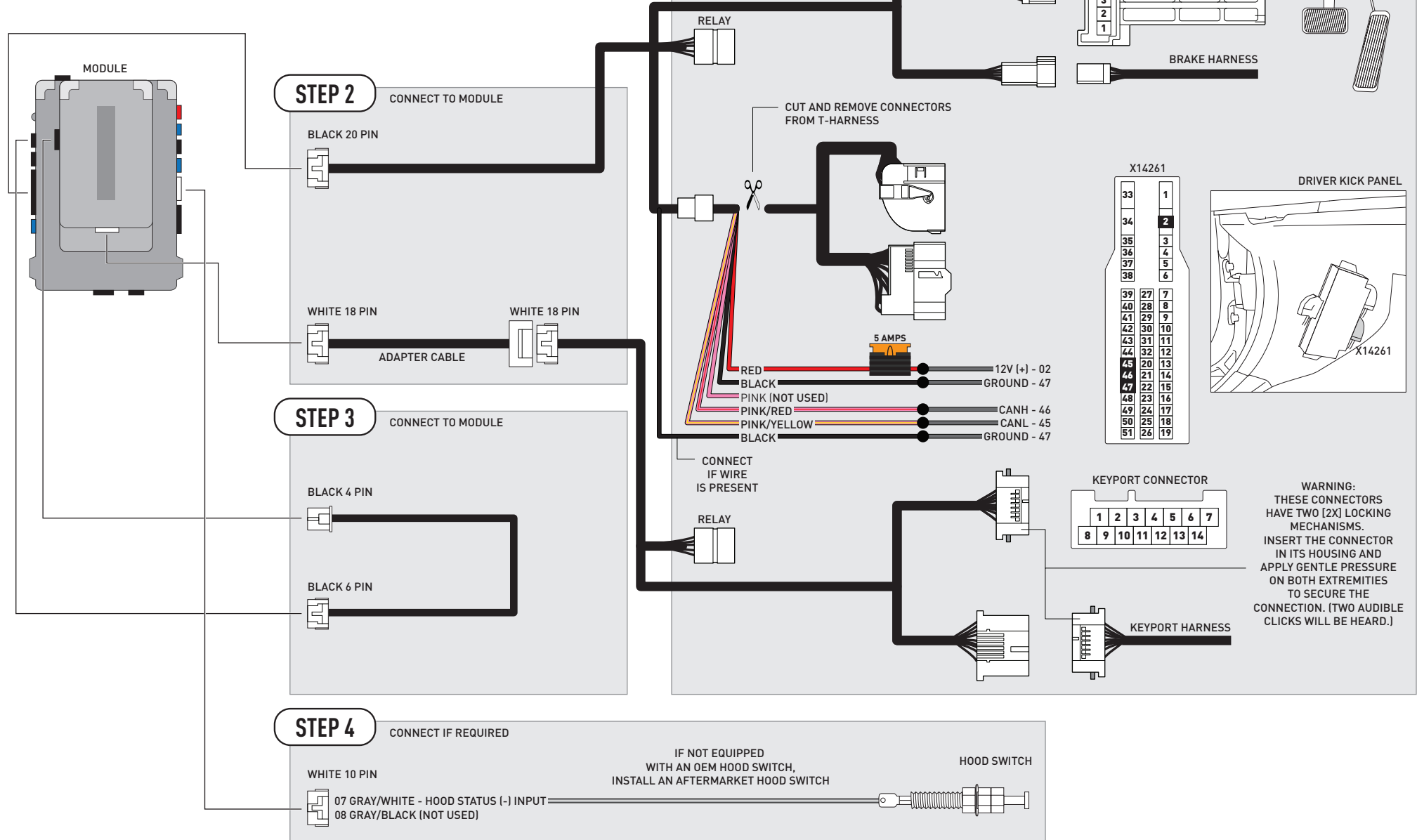

01 LED 1 is solid RED. Insert keyfob 1 into keyport.



02 Within 10 seconds, LED 1 will flash GREEN once (1x).



03 Remove keyfob 1 from keyport.



04 LED 1 will turn solid RED. Wait 5 seconds.



05 Insert keyfob 1 into keyport.



06 Within 10 seconds, LED 1 will flash GREEN rapidly.



07 Remove keyfob 1 from keyport.



08 WARNING: Follow steps 4, 3, 2 as shown in the wiring diagram to disconnect the module from the vehicle.



09 Connect module to computer and proceed with KLON programming.



10 WARNING: Follow steps 2, 3, 4 as shown in the wiring diagram to connect the module to the vehicle.



11 LED 1 will turn solid RED.

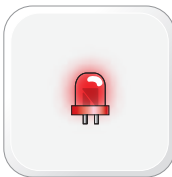

12 Insert keyfob 1 into keyport.



13 LED 1 will turn solid GREEN for 2 seconds.

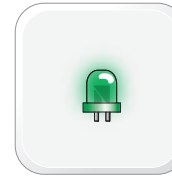

14 Remove keyfob 1 from keyport.



15 Module Programming Procedure completed.

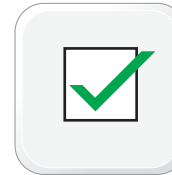

>>



NOTE: In Valet Mode, the Remote starter is not functional. Keyless entry, Lock and Unlock will remain functional. See RF kit user manual for alternate valet mode programming.

01



Insert keyfob into keyport.

02



Time restriction. Complete next step within 7 seconds.

03



Cycle ignition ON five times [5x OFF/ON] rapidly. Parking Light will flash once [1x].

04



Wait, Parking Light will flash twice [2x], pause for 1.5 second, then will flash once [1x] to indicate that the valet mode is ON or twice [2x] to indicate that the valet mode is OFF.

05



Turn ignition to STOP position.

06



Remove keyfob from keyport.

07





Valet Mode Programming Procedure completed.

>>



To exit valet mode: repeat steps 1 to 6.

>>  It is mandatory to exit the Module Navigation at the end of this procedure. Failure to exit the Module Navigation will drain vehicle battery. To exit the Module Navigation at any time: Follow STEP 13.

>>  Module must be programmed to the vehicle.

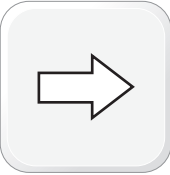
>>  Use the Module Navigation Chart on the next page.

01  Set ignition to OFF position.

02  TO ACCESS THE MENUS: Press and hold programming button until LED 1 turns solid GREEN.

03  IN THE MENUS: Press the programming button as many times as the menu number indicates. LED 1 will flash GREEN an equal amount of times continuously.

04  TO ACCESS THE OPTIONS: Press and hold programming button until LED 1 turns solid RED.

05  IN THE OPTIONS: Press the programming button as many times as the option number indicates. LED 1 will flash RED an equal amount of times continuously.

06  TO ACCESS THE SETTINGS: Press and hold programming button until LED 1 turns solid GREEN.

07  LED 1 will flash GREEN as many times as the current (or default) setting number, continuously.

08  IN THE SETTINGS: Press the programming button as many times as necessary to access your setting. LED 1 will flash GREEN an equal amount of times continuously.

09  To return to the MENUS: exit the Module Navigation and redo the Module Navigation Procedure.

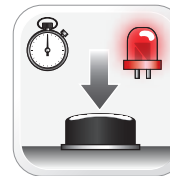
10  To save and return to the OPTIONS: Press and hold programming button until LED 1 turns solid RED.

11  LED 1 will flash RED as many times as the current option number continuously.

12  Configure every other setting and proceed to step 13.

13  MANDATORY: EXIT MODULE NAVIGATION. Press and hold programming button for 7 seconds. LED 1 will flash RED rapidly. Release programming button. LED 1 will turn OFF.

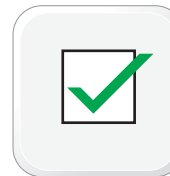
14  Module navigation completed.

>>  Failure to exit the Module Navigation will drain vehicle battery.

MODULE NAVIGATION CHART: NOTES	[X] MENUS	[Y] OPTIONS	[Z] SETTINGS	
I Default settings are listed in bold. II Make sure the option is covered on the vehicle before attempting to change the setting.	01 CONFIGURATION	01 DISARM/UNLOCK BEFORE START	01 OFF 02 ON	
		02 RELOCK AFTER START	01 OFF 02 ON	
		03 RELOCK AFTER SHUTDOWN	01 OFF 02 ON	
		04 FORCE UNLOCK ALL ON FIRST PRESS	01 OFF 02 ON	
		05 TAKEOVER	01 ENABLE 02 DISABLE*	
		06 SECURE TAKEOVER DELAY	01 45 SEC 02 90 SEC 03 03 MIN 04 04 MIN	
		07 FACTORY KEYLESS RS SEQUENCE	01 DISABLE 02 N/A 03 LOCK + UNLOCK + LOCK 04 LOCK + LOCK + LOCK	
		08 MODULE RUN TIME	01 03 MIN 02 05 MIN 03 10 MIN 04 15 MIN 05 25 MIN 06 30 MIN 07 35 MIN 08 15 MIN	
		09 WAIT TO START DELAY	01 02 SEC 02 05 SEC 03 08 SEC 04 10 SEC 05 15 SEC 06 20 SEC 07 25 SEC 08 30 SEC	
		10-15 N/A	01 N/A	
		02-07 Technical Support only	01 N/A	01 N/A

*Vehicle will shutdown when a door is opened.

REMOTE STARTER ERROR CODES: NOTES	[X] NUMBER OF PARKING LIGHT FLASHES	DIAGNOSTIC
I WARNING: The following applies only when the parking lights are connected and supported by the system.	03	Foot brake is ON.
	04	Hood is open.
II After a remote starter failure, the parking lights will flash [X] number times to indicate an error code. See table.	05	Engine tach signal is lost.
	06	System is in Valet Mode.
	07	Vehicle is moving (VSS).
	08	Glow plug timeout error.
	09	RS not synchronized. Start vehicle with OEM key for 15 sec before trying a new RS sequence.
	10	N/A
	11	N/A
	12	N/A
	13	N/A
	14	N/A
	15	N/A
	16	CAN communication failure during RS sequence.

TEST MODULE		LED 1 STATUS	DIAGNOSTIC
I	DURING PROGRAMMING	Flashing RED	Missing/wrong information from firmware or vehicle.
		Solid RED	Module waiting for more vehicle information.
		Flashing GREEN	Additional steps required to complete module programming.
		Solid GREEN then OFF	Module correctly programmed.
		OFF	No activity or module already programmed.
II	DURING REMOTE START	Flashing RED	Module incorrectly programmed.
		Solid RED	Module incorrectly programmed.
		Flashing GREEN	Module correctly programmed and operational.
		Solid GREEN then OFF	Reset in progress.
		OFF	Invalid ground when running status from remote starter.
III	WITH IGNITION OFF	Flashing RED	Module incorrectly programmed or connected.
		Solid RED	Module not programmed. Waiting for more vehicle information.
		Flashing GREEN	False ground when running status from remote starter.
		Solid GREEN then OFF	Reset in progress.
		OFF	Module at rest and ready for a remote start sequence.

01 Disconnect all connectors from module except the BLACK 20-PIN connector.

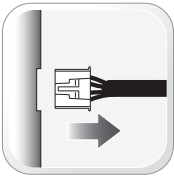

02 Disconnect the BLACK 20-PIN connector.

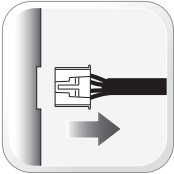

03 PRESS AND HOLD programming button while connecting the BLACK 20-PIN connector.



04 Wait, LED 1 will flash RED. RELEASE programming button.



05 LED 1 will turn RED for 2 seconds.

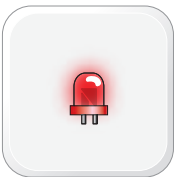

06 Module RESET completed.



07 Reconnect all connectors.

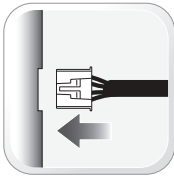

08 Repeat programming procedure.



>> Failure to follow procedure may result with a DTC or a CHECK ENGINE error message.



>>



All vehicle doors must be closed and locked prior to remote start sequence.

01



Time restriction. Complete steps 2 to 5 within 45 seconds.

02



Unlock driver door.

03



Open driver door and enter vehicle.

04



Close driver door.

05



Press and release BRAKE pedal.

06



Take over procedure completed.

>>



Failure to follow procedure will result in vehicle engine shutdown.

CHECKLIST	
01	WARNING: Vehicle engine will start many times. Test in a well ventilated area.
02	Open driver door window for easy vehicle access.
03	Close all vehicle doors, hood and trunk.
04	Press LOCK button three times [3x] rapidly on the OEM keyfob to remote start vehicle.
	QUESTION 1: Does the vehicle remote start?
<input type="checkbox"/>	YES: Go to step 5.
<input type="checkbox"/>	NO: The module doesn't detect OEM remote lock button from the vehicle communication network. Check all connection, repeat step 4 and call technical support if the problem persist.
05	Press LOCK button three times [3x] rapidly on the OEM keyfob to shut down vehicle.
	QUESTION 2: Does the vehicle shut down?
<input type="checkbox"/>	YES: Go to step 6.
<input type="checkbox"/>	NO: Repeat step 5. If problem persists, push vehicle start button once [1x] to shut down the vehicle and call technical support.
06	Unlock and open driver door.
07	Press LOCK button three times [3x] rapidly on the OEM keyfob to remote start vehicle.
	QUESTION 3: Does the vehicle remote start?
<input type="checkbox"/>	YES: The module does NOT detect the door signal from the vehicle communication network. Press LOCK button three times [3x] rapidly on the OEM keyfob to shut down vehicle and call technical support.
<input type="checkbox"/>	NO: Go to step 8.
08	Open hood.
	QUESTION 4: Is the orange warning sticker "Sticker 1" placed under the hood?
<input type="checkbox"/>	YES: Leave hood open and go to step 9.
<input type="checkbox"/>	NO: Put the mandatory orange warning sticker "Sticker 1", leave hood open and go to step 9.
09	Close all doors.
10	Press LOCK button three times [3x] rapidly on the OEM keyfob to remote start vehicle.
	QUESTION 5: Does the vehicle remote start?
<input type="checkbox"/>	YES: Press LOCK button three times [3x] rapidly on the OEM keyfob to shut down vehicle. Go to Question 6.
<input type="checkbox"/>	NO: Go to step 11.
	QUESTION 6: Is the vehicle equipped with a factory hood switch? (Inside hood latch)
<input type="checkbox"/>	YES: The module does NOT detect the hood signal from the vehicle communication network. Call technical support.
<input type="checkbox"/>	NO: Install the mandatory hood switch included in the kit. Repeat installation checklist.
11	Close hood.
12	Enter vehicle. Do NOT press brake pedal.
13	Close all doors.
14	Press LOCK button three times [3x] rapidly on the OEM keyfob to remote start vehicle.
15	Wait for the vehicle to start.
16	Press brake pedal.
	QUESTION 7: Does the vehicle shut down?
<input type="checkbox"/>	YES: Go to step 17.
<input type="checkbox"/>	NO: The module does NOT detect the brake pedal signal from the vehicle communication network. Press LOCK button three times [3x] rapidly on the OEM keyfob to shut down vehicle and call technical support.
17	Apply parking brake.
18	Exit vehicle.

CHECKLIST	
19	Close all doors.
20	Press LOCK button three times [3x] rapidly on the OEM keyfob to remote start vehicle.
21	Wait for the vehicle to start.
	QUESTION 8: Is the vehicle equipped with Comfort Access System ?
<input type="checkbox"/>	YES: For 1, 5, 6, X5, X6: Touch exterior driver door handle to unlock door using Comfort Access System. Within 45 seconds, go to step 22. YES: For 3, X1, Z4, Mini: Press UNLOCK button once [1x] on the OEM keyfob. Within 45 seconds, go to step 22.
<input type="checkbox"/>	NO: Press UNLOCK button once [1x] on the OEM keyfob. Within 45 seconds, go to step 22.
22	Open driver door.
	QUESTION 9: Does the vehicle shut down?
<input type="checkbox"/>	YES: For Z4, X5, X6: Go to step 25. YES: For 1, 3, 5, 6, X1: The module does NOT detect the parking brake signal or the unlock signal from the vehicle communication network. Call technical support.
<input type="checkbox"/>	NO: For Z4, X5, X6: The module does NOT detect the parking brake signal correctly from the vehicle communication network. Call technical support. NO: For 1, 3, 5, 6, X1: Go to step 23.
23	Press and release brake pedal.
24	Push vehicle start button once [1x] to shut down the vehicle.
25	Installation checklist completed.